

Decespugliatrice

M32

M32S

M32X





M32SX

Parallelogram system

M32X 90° rotation arm



M32X

-  Decespugliatrice idraulica serie "GARDEN" adatta per taglio di erba, vegetazione in genere e cespugli. Da applicare a trattori con potenza tra 40 e 50 HP.
-  Our "GARDEN" compact range for cutting grass and bushes. Suited for 40-50 HP tractors.
-  Notre débroussailleuse hydraulique compacte "GARDEN" pour couper l'herbe et les buissons. Pour tracteur de 40 à 50 HP.
-  Hydraulische Böschungsmäher "GARDEN" für gras, vegetation und gebüsch für traktoren von 40 bis 50 HP.



GARDEN GROUP

Decespugliatrice M32/M32S - M32X/M32SX

M32X 90° rotation arm - Parallelogram system

M32/M32S - M32X/M32SX con testata

A	cm 335
B	cm 400
C	cm 350
D	cm 323
E	cm 250
F	cm 103

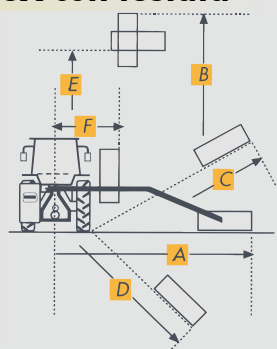

Rotazione testata 190°
Flailhead angling 190°
Rotation groupe de broyage 190°
190° Mähkopf-Neigung

M32/M32S - M32X/M32SX con cimatrice

T	cm 370
S	cm 156
N	cm 101
P	cm 83
P1	cm 89
L1	cm 250
W	cm 450
N2	cm 140
N3	cm 110

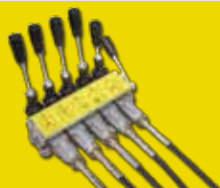
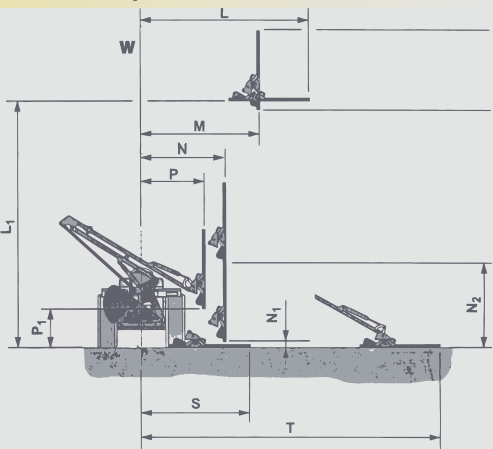

Comandi a cavo flessibili
Cable controls
Commande à câbles
Fernbedienung mit 4
Bowdenzüge/Elektrohydraulische



Comando elettrico con manovela ergonomica
Electric control by means of an ergonomic monolever
Commande électrique avec mono-levier
Elektrohydraulische Bedienung mit Multifunktions-
steuerknüppel (Joystick)



	cm	HP	g/min	Kg	Kg	n°	HP	PTO	lt
M32	80	15	2800	1100	410	32	40/50	540	75
M32S	80	25	2800	1100	420	32	40/50	540	75
M32X	80	15	2800	1300	435	32	40/50	540	75
M32SX	80	25	2800	1300	445	32	40/50	540	75



Tiranti stabilizzatori con cardano
Stabilizers and cardan joint

Cardan et couple blocages

Dreipunktbock - Gelenkwelle und Spannvorrichtung



Sistema flottante sulla testata e sul primo braccio
Floating system on the first arm and on the rotor

Système flottant sur la tête de broyage et sur le rotor

Schwimmstellung (Bodenanpassung des Mähkopfes)



Dispositivo di sicurezza idraulico con valvola registrabile
Hydraulic breakaway with adjustable valve

Dispositif de sécurité hydraulique avec valve réglable

Hydraulische Anfahrssicherung mit einstellbarem Ventil



GARDEN GROUP

DOTAZIONE DI SERIE

- Possibilità di lavoro in retroversione (sinistra/destra) e frontale
- Fermi di sicurezza meccanica per trasporto stradale
- Sicurezza idraulica su bilanciere con valvola registrabile a ritorno automatico
- Doppio senso di rotazione del rotore
- Sistema flottante sul primo braccio e sul rotore
- Attacco ai 3 punti
- Tiranti di bloccaggio
- Comandi a distanza con 4 cavi flessibili
- Rullo posteriore regolabile
- Coltelli snodati taglio max 2-3 cm
- Albero cardanico
- Rotore elicoidale
- Testata cm 80 "Green 800"
- Minimo ingombro in posizione di trasporto cm 190

M32S/M32SX

- Scambiatore di calore
- Kit pompe HP 25

STANDARD EQUIPMENT

- Possibility of reversibility (left/ right assembling)
- Safety mechanical lock for transport on the road
- Hydraulic security with adjustable valve
- Rotor reverse
- Floating system on the first arm and flailhead
- Connection by 3 points
- Cardan joint and stabilizers
- Cable controls
- Adjustable roller
- Cm 80 "Green 800" cutting head
- Flains nr.32
- Helicoidal rotor pattern
- Minimum dimension in transport position: cm 190

M32S/M32SX

- Heat exchanger
- Kit pumps HP 25

EQUIPEMENT STANDARD

- Possibilité de réversibilité (drite/ gauche montage)
- Blocage de sécurité mécanique pour le transport sur la route
- Sécurité hydraulique
- Double sens de rotation du rotor
- 1° bras et rotor fourni avec système flottant
- Attelage 3 points avec stabilisateurs
- Commande distributeur par 4 cables-acier
- Rouleau arrière réglable
- Tête de coupe cm 80 "Green 800"
- Fléaux: manilles nr.32
- Cardan et couple blocages
- Rotor hélicoidal
- Dimensions réduites pour le transport: cm 190

M32S/M32SX

- Refroidissement huile
- Kit pompers HP 25

AUSGERÜSTET MIT

- Front – oder Drehsitzausführung möglich
- Sicherungshalterungen für den Straßentransport
- Hydraulische Anfahrssicherung mit einstellbarem Ventil
- Rechts- und Linkslauf des Messerrotors
- Schwimmstellung (Bodenanpassung des Mähkopfes)
- Dreipunktbock
- Gelenkwelle und Spannvorrichtung
- Fernbedienung mit 4 Bowdenzüge
- Einstellbare Hinterwalze
- Direktantrieb auf dem Rotor cm.80 "Green 800"
- Gelenkige Messer Nr. 32 8 reihige spiralförmiger Rotor
- Min. Transport-Ausmaß: cm 190

M32S/M32SX

- Ölkühler
- Pumpe Hp 25

OPTIONAL

- Comando elettrico con manovela ergonomica multifunzioni e avviamento rotore
- Comando elettrico proporzionale "LOAD SENSING"
- Sospensione oleopneumatica del primo braccio
- Barra posteriore antiurto con fanali per il trasporto stradale
- Scambiatore di calore
- Ruote di appoggio antiribaltamento
- Rotore trasmissione diretta cm 100 "GREEN 1000"
- Supporto fissaggio tiranti su trattori non predisposti
- Lama a dischi/coltelli
- Cimatrice per siepi cm 130/150
- MHC 130 per siepi

OPTIONAL

- Electric control by means of an ergonomic monolever and electric starting of the rotor
- Proportional electric control "LOAD SENSING"
- Oleo pneumatic float for the first arm
- Rear shock-proof bar with lights
- Heat exchanger
- Anti-tip over support wheels
- Cm 100 "Green 1000" cutting head
- Special top link connection for tractors with only one top link position
- Disc/Cutter bar
- Hedge cutter cm 130/150
- MHC 130 hedge cutter

OPTION

- Commande électrique avec mono-levier et mise en marche électrique de la tête de coupe
- Commande électrique proportionnelle "LOAD SENSING"
- Suspension oléopneumatique du premier bras
- Barre arrière anti-chock avec feux pour le transport sur la route
- Refroidissement huile
- Roues d'appui anti-basculement
- Tête de coupe cm 100 "Green 1000"
- Support pour fixation des tirants sur tracteurs non predisposés
- Lamier à disques/couteaux
- Tailleuse pour haies cm 130/150
- MHC 130 hedge cutter

ZUBERHÖR AUF ANFRAGE

- Elektrohdraulische Bedienung mit Multifunktions-steuerknüppel (Joystick) und elektrostart des Rotors
- Elektrohdraulische progressiv Bedienung "LOAD SENSING"
- Ölpneumatische Schwimmstellung des Auslegearmes
- Heck - Stangenbeleuchtung
- Ölkühler
- Umsturzschutz - Leiträder
- Direktantrieb auf dem Rotor cm 100 "Green 1000"
- Unterstützung für die Einpflanzung, die auf die Tractoren nicht veranlagt zieht
- Disc/Messer Schneider
- Heckenscherre holz cm 130/150
- MHC 130 Heckenscherre

